

U.S. CONSUMER PRODUCT SAFETY COMMISSION
Washington, DC 20207
Web site: www.cpsc.gov
Toll-free hotline: 1-800-638-2772



How to plan for the unexpected

Preventing Child Drownings

In some of the nation's sunbelt, drowning has been the leading cause of accidental death in the home of children under 5 years old. The information below can help parents and caregivers provide young children with the protection they deserve.

Each year, nationwide, about 300 children under 5 years old drown in swimming pools, usually a pool owned by their family. In addition, more than 2,000 children in that age group are treated in hospital emergency rooms for submersion injuries.

Medical costs for submersion victims during the initial hospitalization alone can be quite high. Costs can range from an estimated \$4,000 for a victim who recovers fully to \$160,000 for a victim with severe brain damage. Some severely brain damaged victims have initial hospital stays in excess of 120 days and expenses in excess of \$300,000.

Following are just a few facts uncovered by the U.S. Consumer Product Safety Commission (CPSC) in a comprehensive study of drowning and submersion incidents involving children under 5

years old in Arizona, California, and Florida.

◆ Seventy-five percent of the submersion victims studied by CPSC were between 1 and 3 years old; 65 percent of this group were boys. Toddlers, in particular, often do something unexpected because their capabilities change daily.

◆ At the time of the incidents, most victims were being supervised by one or both parents. Forty-six percent of the victims were last seen in the house; 23 percent were last seen in the yard or on the porch or patio; and 31 percent were in or around the pool before the accident. In all, 69 percent of the children were not expected to be at or in the pool, yet they were found in the water.

◆ Submersion incidents involving children usually happen in familiar surroundings. Sixty-five

Continued next page

FACTS & FIGURES

Many communities have enacted safety regulations governing residential swimming pools — inground and aboveground. It's up to parents to comply with these regulations. Apart from these laws, parents who own pools, can take their own precautions to reduce the chances of their youngsters accessing the family pool or spa without adult supervision.

percent of the incidents happened in a pool owned by the child's family and 33 percent of the incidents happened in a pool owned by friends or relatives.

◆ Pool submersions involving children happen quickly. A child can drown in the time it takes to answer a phone. Seventy-seven percent of the victims had been missing from sight for 5 minutes or less.

◆ Survival depends on rescuing the child quickly and restarting the breathing process, even while the child is still in the water. Seconds count in preventing death or brain damage.

◆ Child drowning is a silent death. There's no splashing to alert anyone that the child is in trouble.

The following barrier recommendations are the result of identifying key parameters that typically contribute to child drowning in backyard pools. These recommendations are the minimum steps you can take to make your home a safe place for your child.

Barriers are not child-proof, but they provide layers of protection for a child who strays from supervision. Barriers give parents additional time to locate a child before the unexpected becomes a reality.

Barriers include a fence or wall, door alarms for the house, and a power safety cover over the pool.

Barriers also may be used to protect children from accessing hot tubs and spas. Use the following recommendations as a guide:

FENCES & GATES

◆ Install a fence or other barrier, such as a wall, completely around the pool. If the house is part of the barrier, the doors leading from the house to the pool should be protected with an alarm or the pool should have a power safety cover. Alarm and cover details are below.

◆ The fence or other barrier should be at least 4 feet high. It should have no foot- or handholds that could help a young child to climb it.

◆ Vertical fence slats should be less than 4 inches apart to prevent a child from squeezing through.

◆ If the fence is chain link, then no part of the diamond-shaped

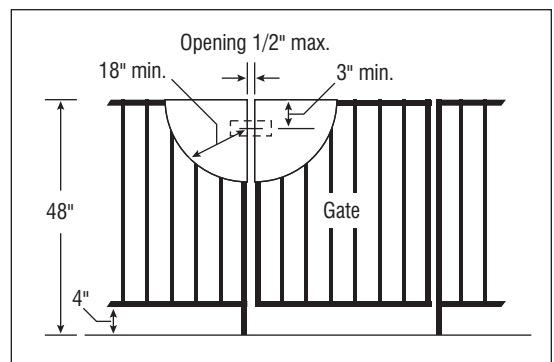
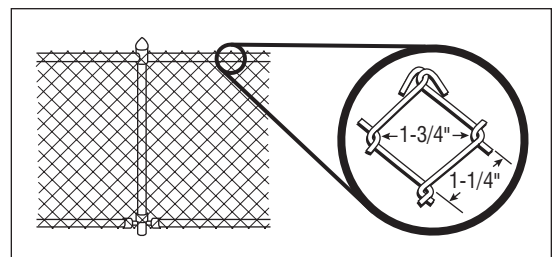

Use this as a guide when the release mechanism is located less than 54 inches from the bottom of the gate.

BARRIERS

If horizontal members are equal to or more than 45 inches apart, vertical spacing shall not exceed 4 inches.

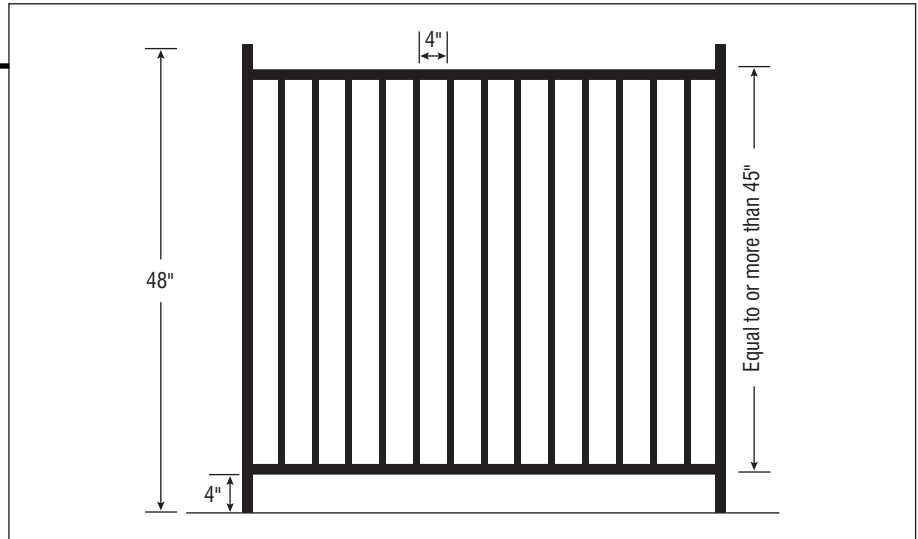

There is a wide variety of fencing construction materials available to compliment your house and pool surroundings. Your local fence company or pool enclosure company can provide you with information and assist you in making a selection.

The weak link in the strongest and highest fence is a gate that fails to close and latch completely. For a gate to close completely every time, it must be in proper working order.

opening should be larger than 1-3/4 inches.

◆ Fence gates should be self-closing and self-latching. The gate should be well maintained to close and latch easily. The latch should be out of a child's reach.

DOOR ALARMS

◆ If the house forms one side of the barrier, then doors leading from the house to the pool should be protected with alarms that produce an audible sound when a door is unexpectedly opened.

◆ Install an alarm that can be temporarily turned off by an adult for a single opening of the door by using a keypad or switch that is out of a child's reach.

Battery and electrically powered alarms are available. The keypad switch can be used by adults who wish to pass through the door without setting off the alarm. It should be placed high on all doors leading from the house to the pool. Affordable and easily installed alarms are available. An alarm signal immediately tells a parent that a door has been opened.

POWER SAFETY COVERS

◆ Power safety covers over the pool may be used as an alternative to door alarms. A power safety cover should meet the requirements of the ASTM pool cover standard that addresses labeling requirements and performance. ASTM requires that a cover withstand the weight of two adults and a child to allow a rescue should an individual fall onto the cover. The standard also requires quick removal of water from the cover. A young child can drown in just inches of water.

A power safety cover is a motor powered barrier that can be placed over the water area. Motor-driven covers easily open and close over the pool. When the power safety cover is properly in place over the pool, it provides a high level of safety for children under 5 years old by inhibiting their access to the water.

ABOVE-GROUND POOLS

◆ Steps and ladders leading from the ground to the pool should be secured and locked, or removed when the pool is not in use.

RULES FOR POOLS

- ❑ Instruct babysitters about potential pool hazards to young children and about the use of protective devices, such as door alarms and latches. Emphasize the need for constant supervision.
- ❑ Never leave a child unsupervised near a pool. During social gatherings at or near a pool, appoint a “designated watcher” to protect young children from pool accidents. Adults may take turns being the “watcher.” When adults become preoccupied, children are at risk.
- ❑ If a child is missing, check the pool first. Seconds count in preventing death or disability. Go to the edge of the pool and scan the entire pool, bottom and surface, as well as the pool area.
- ❑ Do not allow a young child in the pool without an adult.
- ❑ Do not consider young children to be drown proof because they have had swimming lessons. Children must be watched closely while swimming.
- ❑ Do not use flotation devices as a substitute for supervision.
- ❑ Learn CPR (cardiopulmonary resuscitation). Babysitters and other caretakers, such as grandparents and older siblings, should also know CPR.
- ❑ Keep rescue equipment by the pool. Be sure a telephone is poolside with emergency numbers posted nearby.
- ❑ Remove toys from in and around the pool when it is not in use. Toys can attract young children to the pool.
- ❑ Never prop open the gate to a pool barrier.

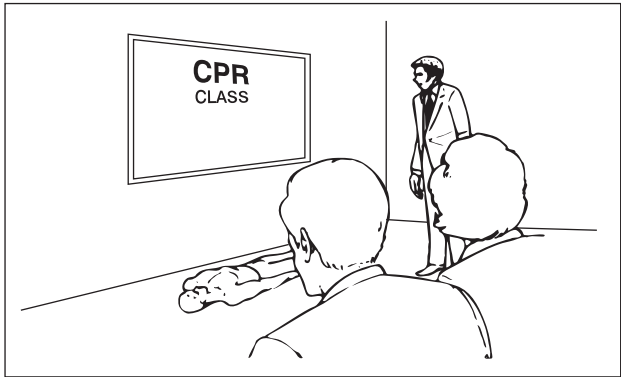
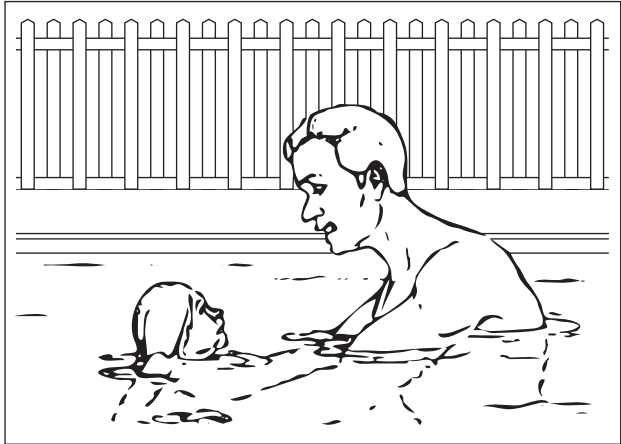

NOTE: To obtain detailed barrier recommendations, write CPSC, Pool Barriers, Office of Information & Public Affairs, Washington, DC 20207. For more information, call the CPSC’s toll-free hotline at 1-800-638-2772 or visit its website at <http://www.cpsc.gov>.

SAFETY BARRIER GUIDELINES FOR HOME POOLS

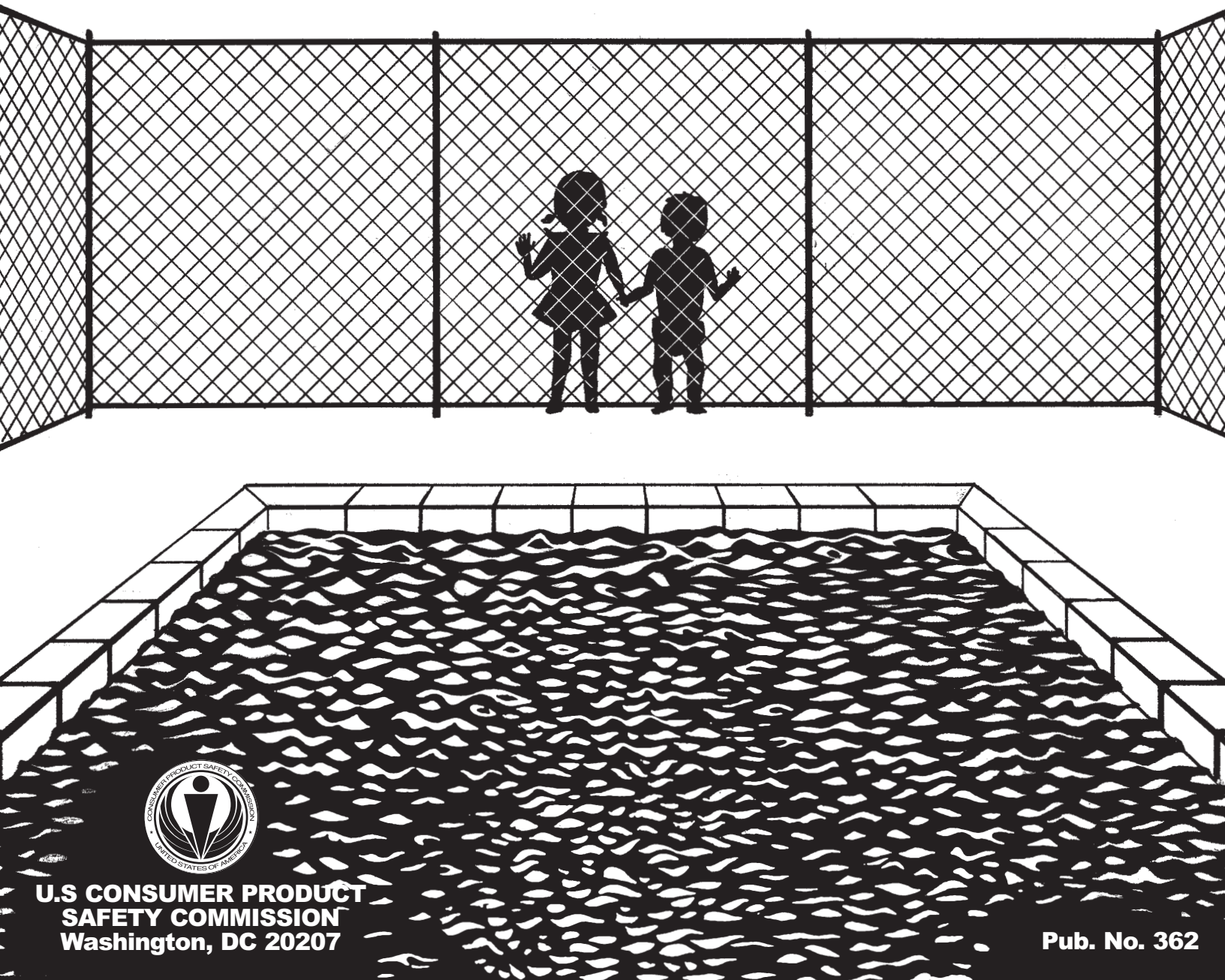

U.S. CONSUMER PRODUCT
SAFETY COMMISSION
Washington, DC 20207

Pub. No. 362

Swimming pools should always be happy places. Unfortunately, each year thousands of American families confront swimming pool tragedies—drownings and near-drownings of young children. These tragedies are preventable. This U.S. Consumer Product Safety Commission (CPSC) handbook offers guidelines for pool barriers that can help prevent most submersion incidents involving young children.

This handbook is designed for use by owners, purchasers, and builders of residential pools, spas, and hot tubs.

The swimming pool barrier guidelines are not a CPSC standard and are not mandatory requirements. Therefore, the Commission does not endorse these guidelines as the sole method to minimize pool drownings of young children. The Commission believes, however, that the safety features recommended in this handbook will help make pools safer. Publication of this handbook is expected to promote pool safety awareness among owners, purchasers and builders of swimming pools.

Some localities have incorporated the guidelines in this handbook into their building codes. Check with your local authorities to see whether these guidelines are included in your area's building code or in other regulations.

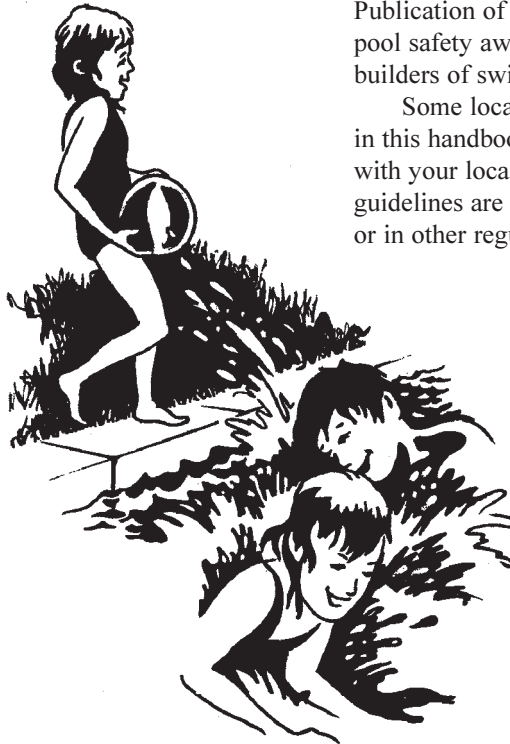

Why the Swimming Pool Guidelines Were Developed

Each year, hundreds of young children die and thousands come close to death due to submersion in residential swimming pools. CPSC has estimated that each year about 300 children under 5 years old drown in swimming pools. The Commission estimates hospital emergency room treatment is required for more than 2,000 children under 5 years of age who were submerged in residential pools.

CPSC did an extensive study of swimming pool accidents, both fatal drownings and near-fatal submersions, in California, Arizona and Florida, states in which home swimming pools are very popular and in use during much of the year. The findings from that study led Commission staff to develop the guidelines in this handbook.

- In California, Arizona and Florida, drowning was the leading cause of accidental death in and around the home for children under the age of 5 years.
- 75 percent of the children involved in swimming pool submersion or drowning accidents were between 1 and 3 years old.
- Boys between 1 and 3 years old were the most likely victims of fatal drownings and near-fatal submersions in residential swimming pools.

- Most of the victims were being supervised by one or both parents when the swimming pool accident occurred.

- Nearly half of the child victims were last seen in the house before the pool accident occurred. In addition, 23 percent of the accident victims were last seen on the porch or patio, or in the yard.

- This means that fully 69 percent of the children who became victims in swimming pool accidents were not expected to be in or at the pool, but were found drowned or submerged in the water.

- 65 percent of the accidents occurred in a pool owned by the victim's immediate family, and 33 percent of the accidents occurred in pools owned by relatives or friends.

- Fewer than 2 percent of the pool accidents were a result of children trespassing on property where they didn't live or belong.

- 77 percent of the swimming pool accident victims had been missing for five minutes or less when they were found in the pool drowned or submerged.

The speed with which swimming pool drownings and submersions can occur is a special concern: by the time a child's absence is noted, the child may have drowned. Anyone who has cared for a toddler knows how fast young children can move. Toddlers are inquisitive and impulsive and lack a realistic sense of danger. These behaviors, coupled with a child's ability to move quickly and unpredictably make swimming pools particularly hazardous for households with young children.

Swimming pool drownings of young children have another particularly insidious feature: these are silent deaths. It is unlikely that splashing or screaming will occur to alert a parent or caregiver that a child is in trouble.

CPSC staff have reviewed a great deal of data on drownings and child behavior, as well as information on pool and pool barrier construction. The staff concluded that the best way to reduce child drownings in residential pools was for pool owners to construct and maintain barriers that would prevent young children from gaining access to pools. However, there are no substitutes for diligent supervision.

The Swimming Pool Barrier Guidelines

How to Prevent a Child from Getting OVER a Pool Barrier

This section explains the CPSC swimming pool barrier guidelines with illustrated descriptions of pool barriers. Definitions of terms used in the guidelines are provided on page 6.

The definition of pool includes spas and hot tubs; the swimming pool barrier guidelines therefore apply to these structures as well as to conventional swimming pools.

A successful pool barrier prevents a child from getting OVER, UNDER, or THROUGH and keeps the child from gaining access to the pool except when supervising adults are present.

A young child can get over a pool barrier if the barrier is too low or if the barrier has handholds or footholds for a child to use when climbing.

The guidelines recommend that the top of a pool barrier be at least 48 inches above grade, measured on the side of the barrier which faces away from the swimming pool.

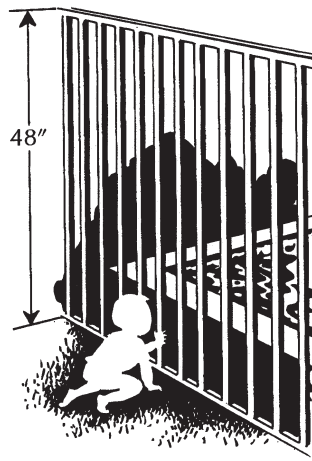

Guidelines recommend eliminating handholds and footholds and minimizing the size of openings in a barrier's construction.

For a Solid Barrier:

No indentations or protrusions should be present, other than normal construction tolerances and masonry joints.

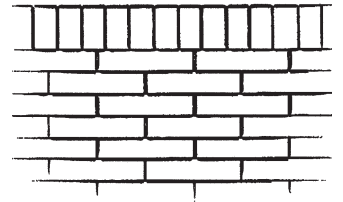

For a Barrier (Fence) Made Up of Horizontal and Vertical Members:

If the distance between the tops of the horizontal members is less than 45 inches, the horizontal members should be on the swimming pool side of the fence. The spacing of the vertical members should not exceed 1-3/4 inches. This size is based on the foot width of a young child and is intended to reduce the potential for a child to gain a foothold. If there are any decorative cut-outs in the fence, the space within the cutouts should not exceed 1-3/4 inches.

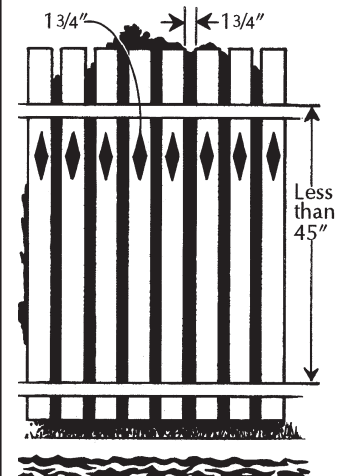

If the distance between the tops of the horizontal members is **more** than 45 inches, the horizontal members can be on the side of the fence facing away from the pool. The spacing between vertical members should not exceed 4 inches. This size is based on the head breadth and chest depth of a young child and is intended to prevent a child from passing through an opening. Again, if there are any decorative cutouts in the fence, the space within the cutouts should not exceed 1-3/4 inches.

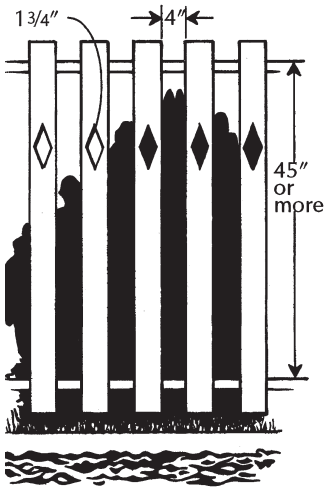

For a Chain Link Fence:

The mesh size should not exceed 1-1/4 inches square unless slats, fastened at the top or bottom of the fence, are used to reduce mesh openings to no more than 1-3/4 inches.

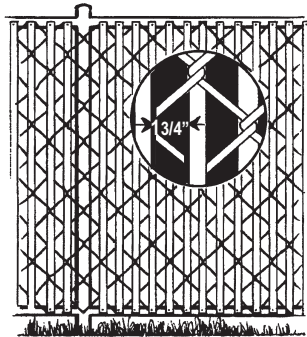
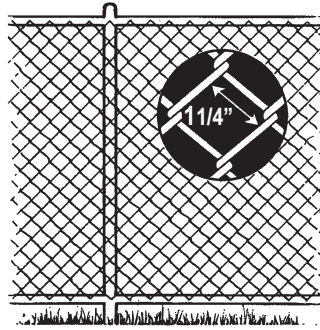

For a Fence Made Up of Diagonal Members (Latticework):

The maximum opening in the lattice should not exceed 1-3/4 inches.

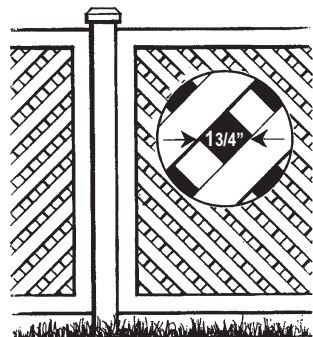

For Aboveground Pools:

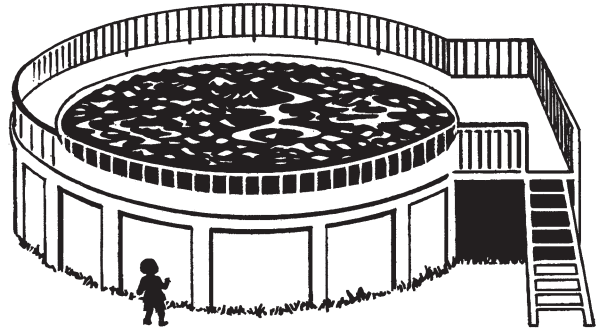

Aboveground pools should have barriers. The pool structure itself serves as a barrier or a barrier is mounted on top of the pool structure.

Then, there are two possible ways to prevent young children from climbing up into an aboveground pool. The steps or ladder can be designed to be secured, locked or removed to prevent access, or the steps or ladder can be surrounded by a barrier such as those described above.

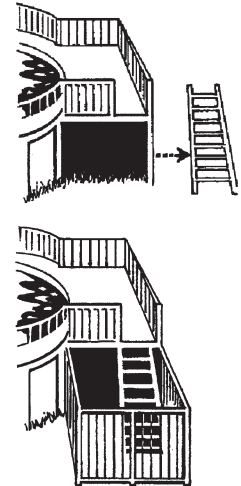

How to Prevent a Child from Getting UNDER a Pool Barrier

For any pool barrier, the maximum clearance at the bottom of the barrier should not exceed 4 inches above grade, when the measurement is done on the side of the barrier facing away from the pool.

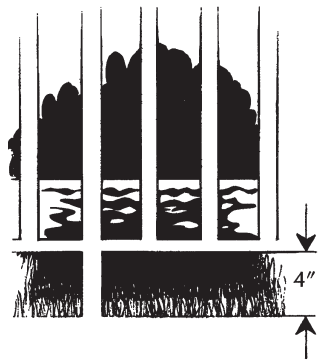

Aboveground Pool with Barrier on Top of Pool:

If an aboveground pool has a barrier on the top of the pool, the maximum vertical clearance between the top of the pool and the bottom of the barrier should not exceed 4 inches.

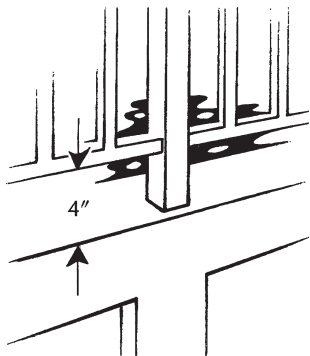

How to Prevent a Child from Getting THROUGH a Pool Barrier

Preventing a child from getting through a pool barrier can be done by restricting the sizes of openings in a barrier and by using self-closing and self-latching gates.

To prevent a young child from getting through a fence or other barrier, all openings should be small enough so that a 4-inch diameter sphere cannot pass through. This size is based on the head breadth and chest depth of a young child.

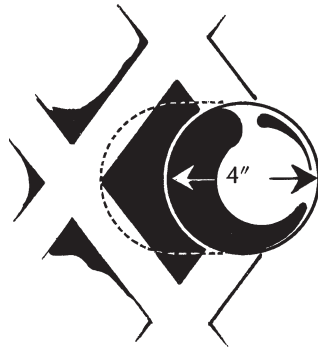

Gates:

There are two kinds of gates which might be found on a residential property. Both can play a part in the design of a swimming pool barrier.

Pedestrian Gates:

These are the gates people walk through. Swimming pool barriers should be equipped with a gate or gates which restrict access to the pool. A locking device should be included in the gate design. Gates should open out from the pool and should be self-closing and self-latching. If a gate is properly designed, even if the gate is not completely latched, a young child pushing on the gate in order to enter the pool area will at least close the gate and may actually engage the latch.



When the release mechanism of the self-latching device is less than 54 inches from the bottom of the gate, the release mechanism for the gate should be at least 3 inches below the top of the gate on the side facing the pool. Placing the release mechanism at this height prevents a young child from reaching over the top of a gate and releasing the latch.

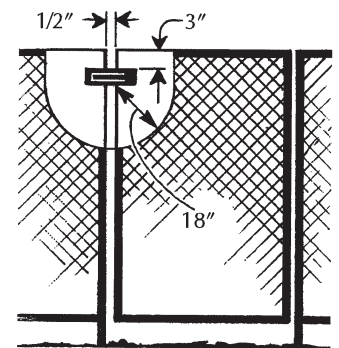

Also, the gate and barrier should have no opening greater than 1/2 inch within 18 inches of the latch release mechanism. This prevents a young child from reaching through the gate and releasing the latch.

All Other Gates (Vehicle Entrances, Etc.):

Other gates should be equipped with self-latching devices. The self-latching devices should be installed as described for pedestrian gates.

When the House Wall Forms Part of the Pool Barrier:

In many homes, doors open directly onto the pool area or onto a patio which leads to the pool.



In such cases, the wall of the house is an important part of the pool barrier, and passage through any doors in the house wall should be controlled by security measures. The importance of controlling a young child's movement from house to pool is demonstrated by the statistics obtained during CPSC's study of pool incidents in California, Arizona and Florida: almost half (46 percent) of the children who became victims of pool accidents were last seen in the house just before they were found in the pool.

All doors which give access to a swimming pool should be equipped with an audible alarm which sounds when the door and/or screen are opened. The alarm should sound for 30 seconds or more **within 7** seconds after the door is opened. *Alarms should*

meet the requirements of UL 2017 General-Purpose Signaling Devices and Systems, Section 77.

The alarm should be loud: at least 85 dBA (decibels) when measured 10 feet away from the alarm mechanism. The alarm sound should be distinct from other sounds in the house, such as the telephone, doorbell and smoke alarm. The alarm should have an automatic reset feature.

Because adults will want to pass through house doors in the pool barrier without setting off the alarm, the alarm should have a switch that allows adults to temporarily deactivate the alarm for up to 15 seconds. The deactivation switch could be a touchpad (keypad) or a manual switch, and should be located at least 54 inches above the threshold of the door covered by the alarm. This height was selected based on the reaching ability of young children.

Power safety covers can be installed on pools to serve as security barriers. Power safety covers should conform to the specifications in ASTM F 1346-91. This standard specifies safety performance requirements for pool covers to protect young children from drowning.

If you wish further information on this standard, contact ASTM, Inc., Philadelphia, Pa. (formerly the American Society for Testing & Materials), directly.

Self-closing doors with self-latching devices could also be used to safeguard

doors which give ready access to a swimming pool.

Indoor Pools:

When a pool is located completely within a house, the walls that surround the pool should be equipped to serve as pool safety barriers. Measures recommended above where a house wall serves as part of a safety barrier also apply for all the walls surrounding an indoor pool.

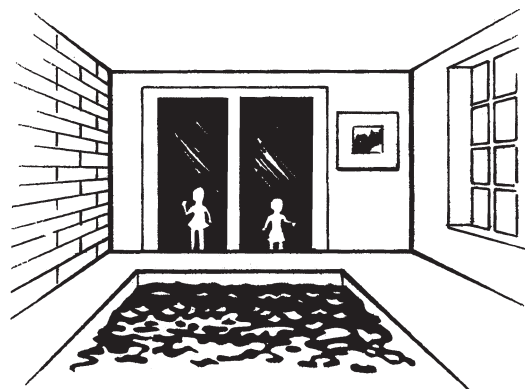

Barriers for Residential Swimming Pool, Spas, and Hot Tubs

The preceding explanations of the U.S. Consumer Product Safety Commission's pool barrier guidelines were provided in order to make it easier for pool owners, purchasers, builders, technicians and others to understand and apply the guidelines themselves. Detailed guidelines follow. Reading the following guidelines in conjunction with the diagrams previously provided may be especially helpful. For further information, consult your local building department or code authority.

Application

The guidelines presented in this document are intended to provide a means of protection against potential drownings and near-drownings to children under 5 years of age by restricting access to residential swimming pools, spas, and hot tubs.

Definitions

Aboveground/onground pool. See definition of swimming pool.

Barrier. A fence, a wall, a building wall or a combination thereof which completely surrounds the swimming pool and obstructs access to the swimming pool.

Hot tub. See definition of swimming pool.

Inground pool. See definition of swimming pool.

Residential. That which is situated on the premises of a detached one- or two-family dwelling or a one-family townhouse not more than three stories in height.

Spa, nonportable. See definition of swimming pool.

Spa, portable. A non-permanent structure intended for recreational bathing, in which all controls, water- heating, and water-circulating equipment are an integral part of the product and which is cord-connected (not permanently electrically wired).

Swimming pool. Any structure intended for swimming or recreational bathing that contains water over 24 inches deep. This includes inground, above-ground, and onground swimming pools, hot tubs, and spas.

Swimming pool, indoor. A swimming pool which is totally contained within a structure and surrounded on all four sides by walls of said structure.

Swimming pool, outdoor. Any swimming pool which is not an indoor pool.

Guidelines

Section I. Outdoor Swimming Pool

An outdoor swimming pool, including an inground, aboveground, or onground pool, hot tub, or spa, should be provided with a barrier which complies with the following:

1. The top of the barrier should be at least 48 inches above grade measured on the side of the barrier which faces away from the swimming pool. The maximum vertical clearance between grade and the bottom of the barrier should be 4 inches measured on the side of the barrier which faces away from the swimming pool. Where the top of the pool structure is above grade, such as an aboveground pool, the barrier may be at ground level, such as the pool structure, or mounted on top of the pool structure. Where the barrier is mounted on top of the pool structure, the maximum vertical clearance between the top of the pool structure and the bottom of the barrier should be 4 inches.
2. Openings in the barrier should not allow passage of a 4-inch diameter sphere.
3. Solid barriers, which do not have openings, such as a masonry or stone wall, should not contain indentations or protrusions except for normal construction tolerances and tooled masonry joints.

4. Where the barrier is composed of horizontal and vertical members and the distance between the tops of the horizontal members is less than 45 inches, the horizontal members should be located on the swimming pool side of the fence. Spacing between vertical members should not exceed 1-3/4 inches in width. Where there are decorative cutouts, spacing within the cutouts should not exceed 1-3/4 inches in width.

5. Where the barrier is composed of horizontal and vertical members and the distance between the tops of the horizontal members is 45 inches or more, spacing between vertical members should not exceed 4 inches. Where there are decorative cutouts, spacing within the cutouts should not exceed 1-3/4 inches in width.

6. Maximum mesh size for chain link fences should not exceed 1-3/4 inch square unless the fence is provided with slats fastened at the top or the bottom which reduce the openings to no more than 1-3/4 inches.

7. Where the barrier is composed of diagonal members, such as a lattice fence, the maximum opening formed by the diagonal members should be no more than 1-3/4 inches.

8. Access gates to the pool should comply with Section I, Paragraphs 1 through 7, and should be equipped to accommodate a locking device. Pedestrian access gates should open outward, away from the pool, and should be self-closing and have a self-latching device. Gates other than pedestrian access gates should have a self-latching device. Where the release mechanism of the self-latching device is located less than 54 inches from the bottom of the gate, (a) the release mechanism should be located on the pool side of the gate at least 3 inches below the top of the gate

and (b) the gate and barrier should have no opening greater than 1/2 inch within 18 inches of the release mechanism.

9. Where a wall of a dwelling serves as part of the barrier, one of the following should apply:

(a) All doors with direct access to the pool through that wall should be equipped with an alarm which produces an audible warning when the door and its screen, if present, are opened. The alarm should sound continuously for a minimum of 30 seconds **within 7** seconds after the door is opened. *Alarms should meet the requirements of UL 2017 General-Purpose Signaling Devices and Systems, Section 77.* The alarm should have a minimum sound pressure rating of 85 dBA at 10 feet and the sound of the alarm should be distinctive from other household sounds, such as smoke alarms, telephones, and door bells. The alarm should automatically reset under all conditions. The alarm should be equipped with manual means, such as touchpads or switches, to temporarily deactivate the alarm for a single opening of the door from either direction. Such deactivation should last for no more than 15 seconds. The deactivation touchpads or switches should be located at least 54 inches above the threshold of the door.

(b) The pool should be equipped with a power safety cover which complies with ASTM F1346-91 listed below.

(c) Other means of protection, such as self-closing doors with self-latching devices, are acceptable so long as the degree of protection afforded is not less than the protection afforded by (a) or (b) described above.

10. Where an aboveground pool structure is used as a barrier or where the barrier is

mounted on top of the pool structure, and the means of access is a ladder or steps, then (a) the ladder to the pool or steps should be capable of being secured, locked or removed to prevent access, or (b) the ladder or steps should be surrounded by a barrier which meets Section I, Paragraphs 1 through 9. When the ladder or steps are secured, locked, or removed, any opening created should not allow the passage of a 4-inch diameter sphere.

Section II. Indoor Swimming Pool.

All walls surrounding an indoor swimming pool should comply with Section I, Paragraph 9.

Section III. Barrier Locations.

Barriers should be located so as to prohibit permanent structures, equipment or similar objects from being used to climb the barriers.

Exemptions

A portable spa with a safety cover which complies with ASTM F1346-91 listed below should be exempt from the guidelines presented in this document. But, swimming pools, hot tubs, and non-portable spas with safety covers should **not** be exempt from the provisions of this document.

ASTM F1346-91. Standard Performance Specification for Safety Covers and Labeling Requirements for All Covers for Swimming Pools, Spas and Hot Tubs.

For further information, write:
U.S. Consumer Product Safety Commission
Washington, D.C. 20207
Web site: www.cpsc.gov

To report a product hazard or a product-related injury, write to the U.S. Consumer Product Safety Commission, Washington, D.C. 20207, or call the CPSC's toll-free hotline at 1-800-638-2772 or visit its website at <http://www.cpsc.gov>.

A teletypewriter for the hearing and speaking impaired is available on: 1-800-638-8270.

This document is in the public domain. Therefore it may be reproduced, in part or in whole, without permission by an individual or organization. However, if it is reproduced, the Commission would appreciate knowing how it is used.

Write the U.S. Consumer Product Safety Commission, Office of Information and Public Affairs, Washington, D.C. 20207.